

Project Name		Customer Name	
Quote Number		Date	
Customization			

## Standard Features

<b>Type</b>	One-piece roll-in type shower stall with simulated 12" x 24" tile design. Available in left or right hand configuration.
<b>Color</b>	White
<b>Exterior Dimensions</b>	62"W x 36"D x 78-1/2"H
<b>Materials</b>	Gel coat and fiberglass composite
<b>Approximate Weight</b>	140 lbs

## Certifications and Accessibility Code Compliance



Uniform Plumbing Code



CSA B45.5-11 / IAPMO Z124-2017



ADA

ANSI

ICC A117.1 - 2017 ANSI Type A



CA Title 24 Chapter 11A

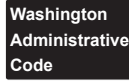

Washington Administrative Code WAC 388-78A-3030

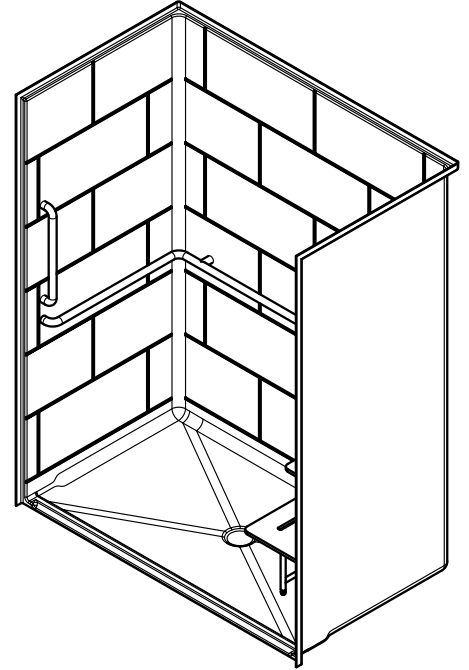

## Warranty

30 Year Limited

## Reinforcement

Fully reinforced with EverFab's unique composite core material which allows for factory or field installation of ADA compliant grab bars and seat

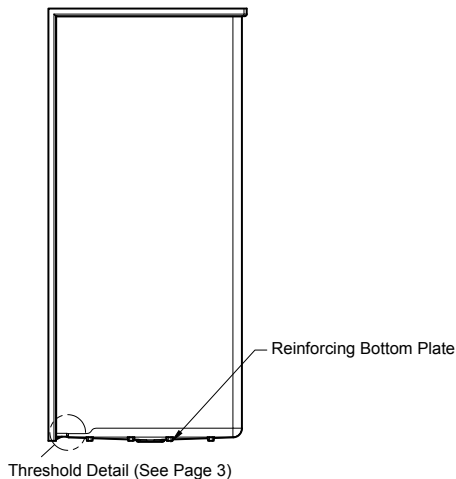
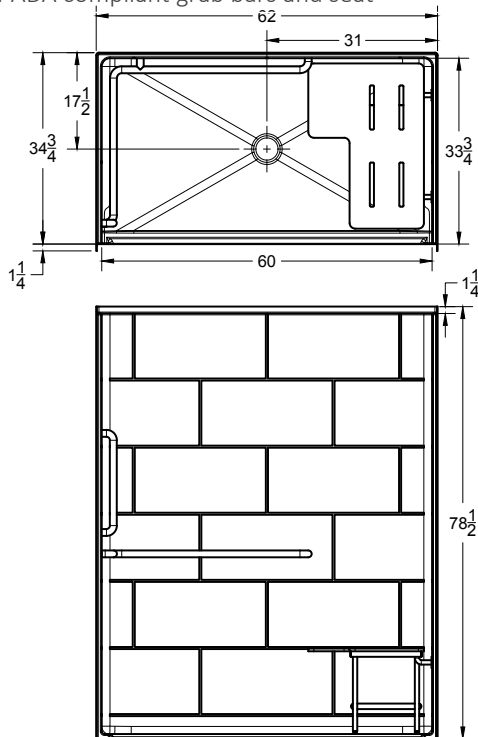

Threshold Detail (See Page 3)



Affordable Housing  
**SHOWERS.com**  
by ORCA HealthCare

[www.affordablehousingshowers.com](http://www.affordablehousingshowers.com)

Quotes and inquiries:  
1-888-286-8030

[info@affordablehousingshowers.com](mailto:info@affordablehousingshowers.com)

## ADA Accessory Dimensions

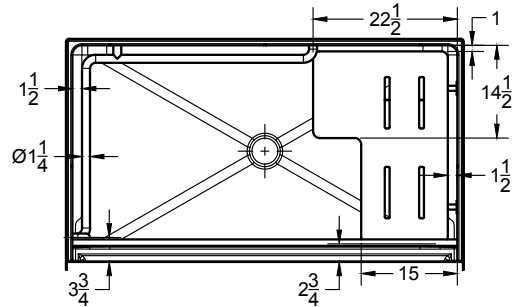

Curtain Rod Detail  
(See Page 3)

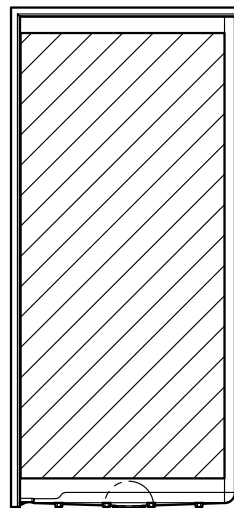
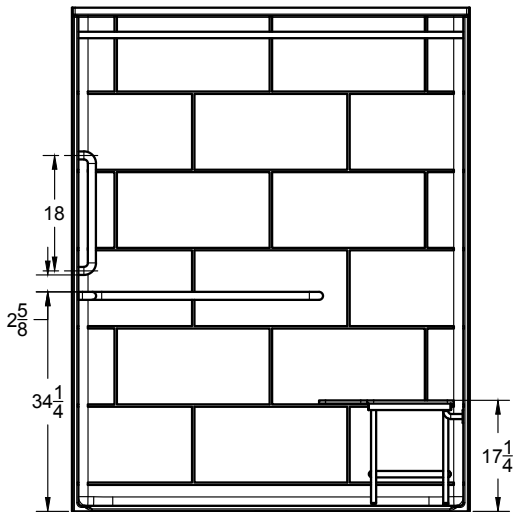
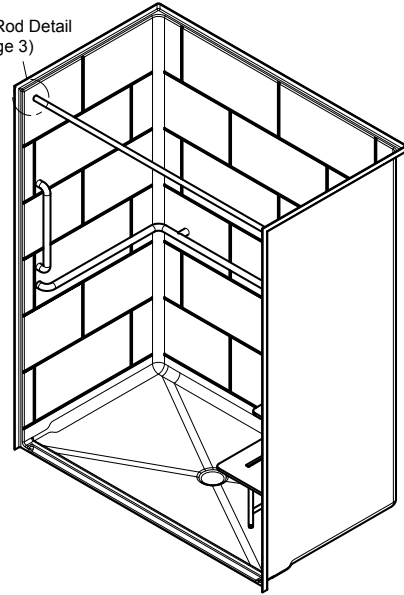

Drain Block Out Detail (See Page 3)

Fully Reinforced  
with EverFab Core  
Material for factory  
or field installation  
of grab bars and  
seat

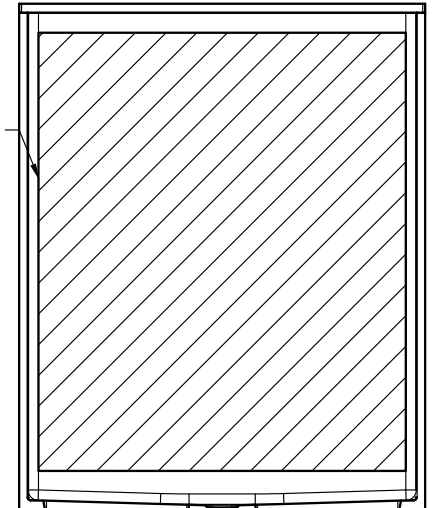

## Architectural Specifications

### A. Shower Stall:

1. Model: No. S6236TA-L/R
2. Description: One-piece shower stall with reinforcing bottom plate, slip-resistant floor, simulated 12" x 24" tile, and inorganic composite reinforcement for placement of grab bars and seat
3. Exterior dimensions: 62 inches wide x 36 inches deep x 78-1/2 inches high
4. Rough-in: +1/8" -0" nominal dimensions
5. Threshold: [Standard] [Low Profile] [No-Recess] Threshold Detail
6. Accessibility Accessories: [A0] [A1] [A2] [A3] [Custom] accessory configuration
7. Non Standard Accessories: Furnish with [curtain rod], [shower curtain], [recessed soap dish], [composite corner shelf], [shower slide-bar kit], [EverFab tub-wrap], [shower drain], [18" grab bar], [24" grab bar], [custom grab bar], [folding seat], [T-shaped EverDam]. If applicable, please indicate location of additional accessories on drawing
8. Accessory Style: [Standard Thru-Bolted], [Flanged], [Anti-Ligature]
9. Accessory Finish: [Standard Satin Stainless], [Matte Black], [Polished Stainless] [White], [Custom]

**ADA Accessory Configurations (number following 'A' indicates configuration)**

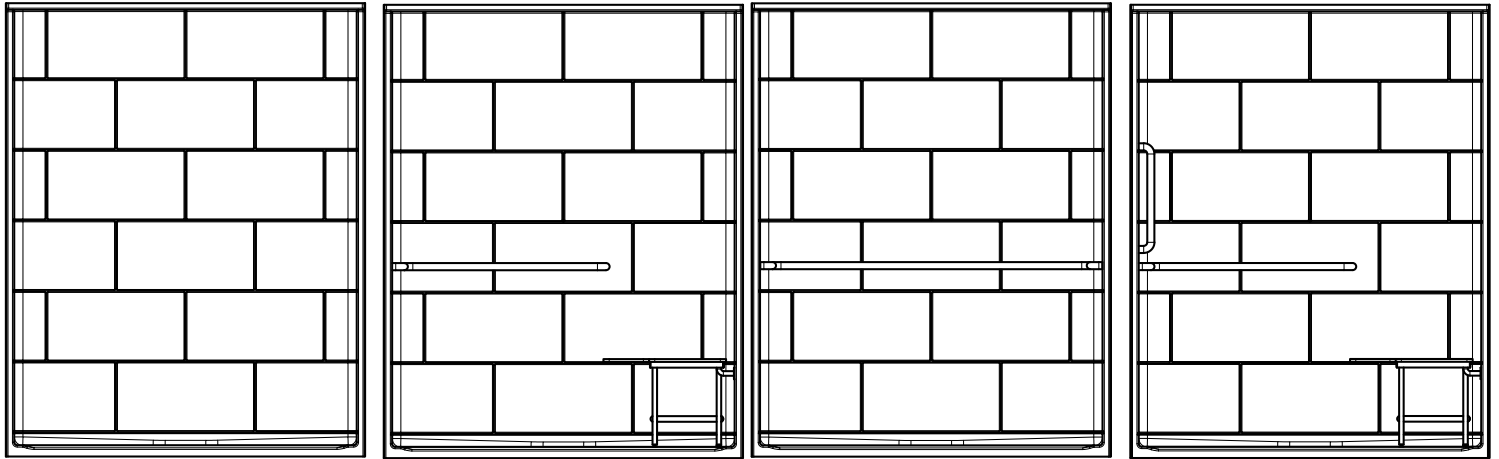

**S6236TA0**

No Accessories

**S6236TA1-R**

L-shaped grab bar  
Seat

**S6236TA2**

U-shaped grab bar

**S6236TA3-R**

L-shaped grab bar  
Seat  
18" vertical grab bar

**Threshold Details**

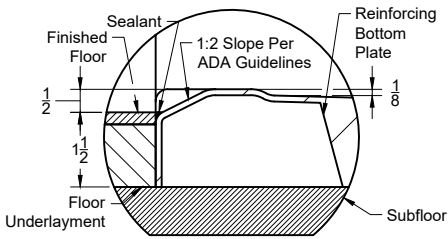

**Standard**

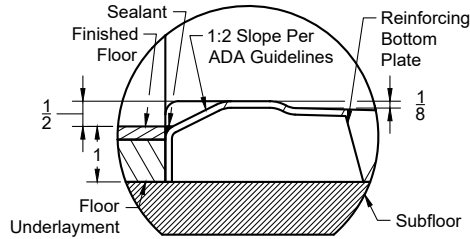

**Low-Profile**

*Model number followed with 'LP'*

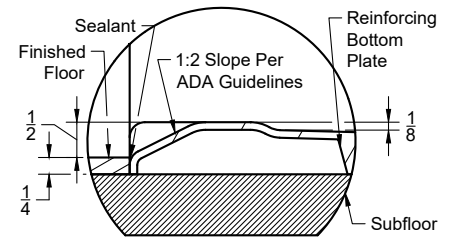

**No-Recess**

*Model number followed with 'NR'*

**Additional Details**

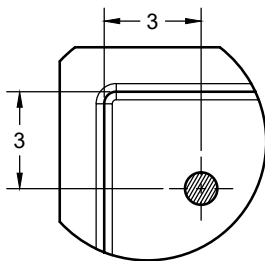

**Standard Curtain Rod Location**

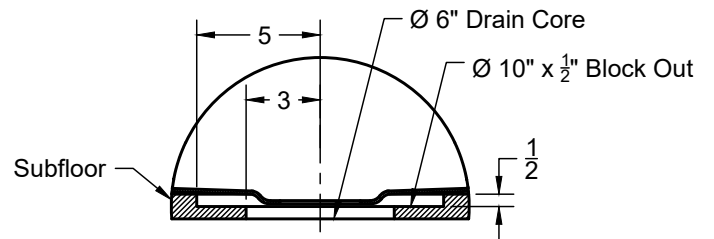

**Drain Block-Out**

## Standard Threshold Model Configurations

Model Number	Pre-Installed L-Shaped Grab Bar	Pre-Installed 18" Vertical Grab Bar	Pre-Installed U-Shaped Grab Bar	Pre-Installed Folding Seat	Drain Block Out Required	Accessibility Code Compliance
<input type="checkbox"/> S6236TA0	No	No	No	No	No	Adaptable**
<input type="checkbox"/> S6236TA1	Yes	No	No	Yes	No	ADA, CA Title 24, WAC, HUD/FHA
<input type="checkbox"/> S6236TA2	No	No	Yes	No	No	ADA, CA Title 24, WAC, HUD/FHA
<input type="checkbox"/> S6236TA3	Yes	Yes	No	Yes	No	ADA, CA Title 24, WAC, ANSI, HUD/FHA

## Low Profile Threshold Model Configurations

Model Number	Pre-Installed L-Shaped Grab Bar	Pre-Installed 18" Vertical Grab Bar	Pre-Installed U-Shaped Grab Bar	Pre-Installed Folding Seat	Drain Block Out Required	Accessibility Code Compliance
<input type="checkbox"/> S6236TA0LP	No	No	No	No	Yes	Adaptable**
<input type="checkbox"/> S6236TA1LP	Yes	No	No	Yes	Yes	ADA, CA Title 24, WAC, HUD/FHA
<input type="checkbox"/> S6236TA2LP	No	No	Yes	No	Yes	ADA, CA Title 24, WAC, HUD/FHA
<input type="checkbox"/> S6236TA3LP	Yes	Yes	No	Yes	Yes	ADA, CA Title 24, WAC, ANSI, HUD/FHA

## No-Recess Threshold Model Configurations

Model Number	Pre-Installed L-Shaped Grab Bar	Pre-Installed 18" Vertical Grab Bar	Pre-Installed U-Shaped Grab Bar	Pre-Installed Folding Seat	Drain Block Out Required	Accessibility Code Compliance
<input type="checkbox"/> S6236TA0NR	No	No	No	No	Yes	Adaptable**
<input type="checkbox"/> S6236TA1NR	Yes	No	No	Yes	Yes	ADA, CA Title 24, WAC, HUD/FHA
<input type="checkbox"/> S6236TA2NR	No	No	Yes	No	Yes	ADA, CA Title 24, WAC, HUD/FHA
<input type="checkbox"/> S6236TA3NR	Yes	Yes	No	Yes	Yes	ADA, CA Title 24, WAC, ANSI, HUD/FHA

\*\*Model is reinforced and capable of meeting accessibility code requirements with proper field-installation of grab bars and seat

## Seat Placement (indicated by '-L' or '-R' following model number if applicable)\*

- Left Hand  Right Hand

\*Seat placement is determined as if outside the unit looking in. For clarity, a right hand model is shown in all drawings.

## Optional/Standalone Accessories†

- |                                      |                         |                                     |                        |
|--------------------------------------|-------------------------|-------------------------------------|------------------------|
| <input type="checkbox"/> CR6001T     | Thru-bolted Curtain Rod | <input type="checkbox"/> SB1800T    | 18" grab bar           |
| <input type="checkbox"/> EF-7272-SC  | Shower Curtain          | <input type="checkbox"/> SB2400T    | 24" grab bar           |
| <input type="checkbox"/> EF-0000-SD  | Recessed Soap Dish      | <input type="checkbox"/> LB30375T   | 30"x37.5" L-bar        |
| <input type="checkbox"/> EF-0000-CCS | Composite Corner Shelf  | <input type="checkbox"/> LS30225    | 30"x22.5" Folding seat |
| <input type="checkbox"/> EF-0000-SK  | Shower Slide-Bar Kit    | <input type="checkbox"/> UB6030T    | 60"x30" U-bar          |
| <input type="checkbox"/> EF-0000-DA  | Shower Drain            | <input type="checkbox"/> EF-0060-ED | T-Shaped EverDam       |

†If applicable, please select accessory style and finish from options below. If non-standard accessory is selected, please also indicate desired location(s) on drawing.

## Accessory Style

- Thu-bolted (Standard)  
 Flanged  
 Anti-ligature

## Accessory Finish

- Satin Stainless (Standard)  
 Matte Black  
 Polished Stainless  
 White  
 Custom, please specify:



Affordable Housing  
**SHOWERS.com**  
 by ORCA HealthCare

[www.affordablehousingshowers.com](http://www.affordablehousingshowers.com)

Quotes and inquiries:

1-888-286-8030

info@affordablehousingshowers.com